



ClearKlens



Hygiene Solutions

Dependable and sustainable hygiene solutions for the Life Sciences Industry



The ClearKlens® Range

Dependable and sustainable hygiene solutions for the Life Sciences industries.

Protecting Production Integrity - efficiently

From sterile disinfectants to clean-in-place wash down systems, ClearKlens solutions deliver dependable cleaning results while enhancing the efficiency and sustainability of your operation.

Developed to meet the specific needs of the Life Sciences Industry manufacturing facilities, the comprehensive range of ClearKlens hygiene solutions can be relied on to protect your production integrity - efficiently.



ClearKlens – Peace of Mind

- Open Plant Cleaning
 - ClearKlens Sterile
 - ClearKlens Non-Sterile
- Cleaning in Place
- Equipment Solutions
- Personal Care
- Facility Management
- Knowledge-Based Services



One stop shop for all your cleaning and hygiene needs

When you partner with Diversey you can fully rely on us for all your cleaning and hygiene needs. Our team will make sure to upgrade your hygiene programs to world class while keeping your spend in control. Whether it is personal hygiene, sanitization programs for high care areas, cleaning program for any equipment or surface, floor cleaning machines or any other hygiene need, we have the solution.

Partnering with our customers to solve hygiene challenges

We have created several pioneering applications for the Pharma Industry, including aqueous cleaning of API's, a wide membrane CIP product range, optimized CIP programs for vessels, rotational floor disinfection programs with a broad spectrum of chemistry, optimized packaging for sterile disinfectants and cleaners and more. We are always keen to work closely with our customers on unique cleaning and hygiene issues and develop robust solutions to the challenge and ensure safe production.

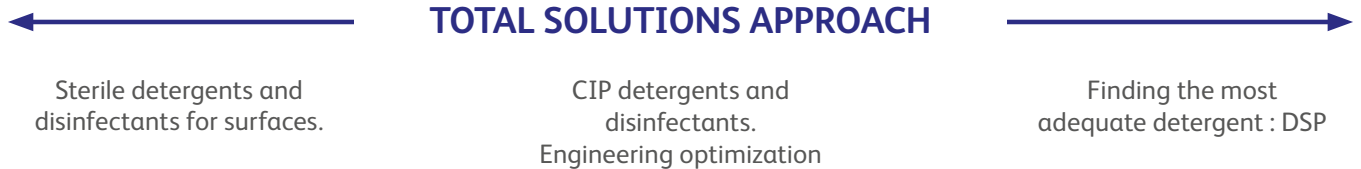
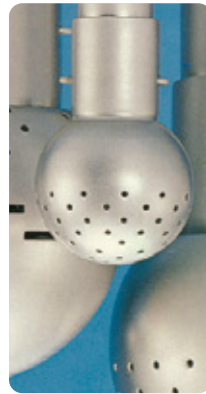

Key features



The ClearKlens product range streamlines the validation process ensuring:



BPR Supported Formulation

The Biocidal Products Regulation (BPR) requires biocidal products to be registered with the European Union and will become the standard for all member states. As a significant investment per formulation you can be rest assured that Diversey ClearKlens is committed to the pharma sector and ensuring that we have a product range that is fit for the purpose.

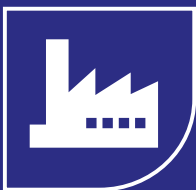

Manufactured in a controlled environment to cGMP

The ClearKlens range is manufactured to cGMP principles (ISO 22716). Our sterile range is manufactured in cleanrooms accredited to the same standards as the cleanrooms the products are designed to be used in.

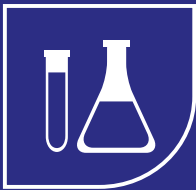

Tested to relevant standards

ClearKlens biocides are tested against relevant standards to prove efficacy against bacteria, fungi, yeasts, spores and viruses. Full test data is available on request.



Standard, protected worldwide formulations

The formulations of ClearKlens products are standard across the globe and are protected from change, ensuring no changes will be made unless for reasons beyond Diversey's control and with extended notice.



Supported with full technical documentation package

The ClearKlens range is supplied with a document package containing relevant documentation including: Certificate of Analysis, Certificate of Irradiation, Certificate of Sterility, Copies of the test data, TOC and ATE data, HPLC test methods for residues, manufacturing specifications and process and packaging specifications where applicable.



Packaging integrity

The ClearKlens sterile range is manufactured in sterile conditions to ensure the integrity of the product. Our packaging has been rigorously tested to ensure the integrity of the product is not compromised before or during use.

Proven Efficacy

Product Name	Bactericidal			Fungicidal				Yeasticidal			Sporicidal	Virucidal
	EN 1276	EN 13727 (MED)	EN 13697	EN 1650	EN 13624 (MED)	EN 13697	EN 16615 (MED)	EN 1650	EN 13624 (MED)	EN 13697	EN 13704	EN 14476 (MNV, Poliovirus and Adenovirus)
Alcohols												
CK IPA	✓		✓					✓		✓		Modified Vaccinia Ankara Virus
CK DE	✓		✓					✓		✓		
Daily disinfectants												
CK Tego 2000 SC		✓	✓						✓	✓		Modified Vaccinia Ankara Virus
CK Tego 2000 SS/RTU		✓	✓						✓	✓		Modified Vaccinia Ankara Virus
CK Cleansinald SC	✓		✓					✓		✓		✓
CK Cleansinald RTU	✓		✓					✓		✓		
Divodes FG	✓			✓		✓		✓		✓		✓
Sporicides												
CK Bi-Spore	✓		✓	✓				✓		✓	✓	✓
CK Oxifast	✓		✓	✓		✓		✓		✓	✓	✓
CIP												
CK Activ			✓			✓		✓		✓	✓	Polio, Murine Parvo, Adeno
CK Mega HP	✓							✓				
CK Deogen	✓		✓	✓		✓		✓		✓		
Cleaner / Disinfectant												
Oxivir Excel	✓	✓	✓		✓		✓	✓	✓	✓		✓
Oxivir Excel RTU (Spray)	✓	✓	✓		✓		✓	✓	✓	✓		✓
Oxivir Excel Wipes	✓	✓					✓	✓	✓			✓
Oxivir Plus	✓	✓	✓	✓	✓	✓	✓	✓	✓	✓	✓	✓
Oxivir Plus RTU (Spray)	✓	✓	✓	✓	✓	✓		✓	✓	✓		✓
Oxivir Sporcide RTU (Spray)	✓	✓	✓	✓	✓	✓	✓	✓	✓	✓	✓	✓
Oxivir Sporcide Wipes	✓		✓	✓	✓		✓	✓	✓		✓	✓

Glossary of Standards

Test method	Test organism	Product pass concentration / time	Temperature	Log reduction required to pass	Type
EN 1276:2010	Staphylococcus aureus Pseudomonas aeruginosa Enterococcus hirae Escherichia coli	5 minutes	20°C	≥ 5 log	Bactericidal
EN 13697:2015	Staphylococcus aureus Pseudomonas aeruginosa Enterococcus hirae Escherichia coli	5 minutes	20°C	≥ 4 log	Bactericidal Fungicidal
EN 1650:2013 + A1 (July 2013)	Candida albicans Aspergillus brasiliensis	15 minutes	20°C	≥ 4 log	Fungicidal Yeasticidal
EN 14476:2013 + A1 (Oct 2017)	Poliovirus Adenovirus– Norovirus and Parvovirus (only for instruments...)	Hands: between 30 s and 3 min Surface: no longer than 5 min (for surfaces in contact with patient or medical staff) or no longer than 60 min (for other surfaces)	20°C	≥ 4 log	Virucidal
EN 13704:2002	Bacillus subtilis	60 minutes	20°C	≥ 3 log	Sporicidal
Medical area					
EN 13727:2015 (equivalent to EN 1276 for medical area)	Staphylococcus aureus Pseudomonas aeruginosa Enterococcus hirae Escherichia coli	5 minutes	20°C	≥ 5 log	Bactericidal
EN 13624:2013 (equivalent to EN 1650 for medical area)	Candida albicans	5 minutes	20°C	≥ 4 log	Yeasticidal
EN 16615:2015	Candida albicans Aspergillus brasiliensis (niger) Staphylococcus aureus Enterococcus hirae Pseudomonas aeruginosa Clostridium difficile	1-5 minutes	20°C	≥ 4 log for Yeast ≥ 4 log for Fungi ≥ 5 log for Bacteria ≥ 3 log for Bacteria Spores	Yeasticidal Fungicidal Bactericidal Bacteria Spores

Open Plant Cleaning (OPC)

It is easy to clean a horizontal surface, however cleaning becomes difficult for vertical surfaces and equipment without CIP using traditional methods of cleaning. As a result these are often left unclean or partially cleaned. Low Pressure Foam / Gel cleaning techniques offered by Diversey brings to you a number of advantages.

- Effective cleaning of intricate, non-accessible places
- Low pressure avoiding aerosol formation
- Products safe for people and the environment
- Cleaning with minimum human effort leading to consistent results

You will find a Diversey product to satisfy every cleaning need, for all kinds of soil, on every surface within your plant. Our unique combination of products (manual/foam/gel), machines, services, technical support, training and systems makes Open Plant Cleaning quick, efficient and effortless.

API Cleaning

Traditionally APIs have been cleaned using solvents. Cleaning with solvents is expensive, time consuming, hazardous to environment and harmful for workers. Most solvents are also flammable in nature making the open-manual activity even more hazardous.

Diversey brings the technology to clean APIs with aqueous detergents. Our proprietary formulations for API cleaning have been tested with more than 100 APIs achieve improved cleaning with a safe, convenient, quick and eco-friendly technology.

Cleaning Mixing Vessels, Sidepots, etc.

We have developed products and systems for cleaning, deodorizing and disinfection of equipment in cosmetic plants. Our range of machines makes cleaning safe and convenient for equipment without CIP systems.

Tablet Coating Machines

We have developed proven cleaning programs for cleaning of tablet coating polymers including Eudragit brand products and HPMC.

Excipient and Powder Formulations Cleaning

We work closely with our customers to choose/ develop custom cleaning program for different formulations and excipients. Contact us with the cleaning challenges faced at your site!

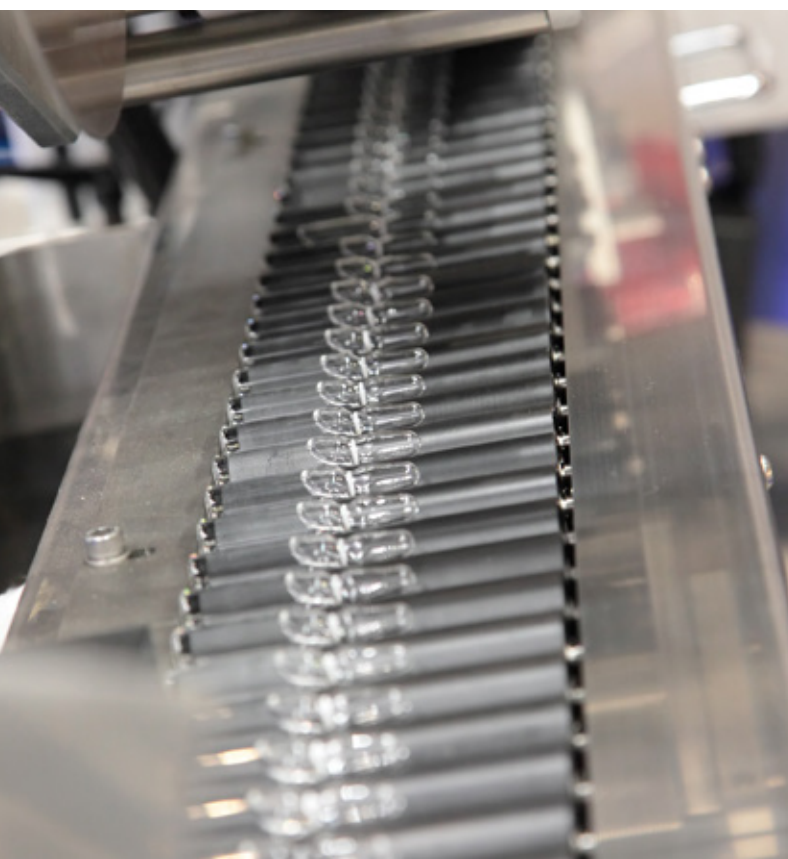

These products are dedicated for the cleaning and/or disinfection of clean rooms surfaces and equipment.

All products are at least double bagged and supported by full documentation in order to streamline the validation process.



Manufactured in a cGMP controlled environment



Endotoxin free



Protected formulas



Packaging Integrity



BPR supported formulations



Technical documentation package



Tested to relevant EU standards



Formulated with WFI (Water for Injection)



Features of the sterile product range:

- Designed for use in iso class 5 facilities
- 0.2 µm filtered
- Double or triple bagged
- Irradiated or sterile filtration
- Sterility tested
- Supplied with physico-chemical certificates of analysis
- Supplied with certificate of irradiation
- Certificates are downloadable at www.clearklens.com

Validation support:

- Physico-chemical specifications
- Corrosion test
- ATE - ADE / PDE values
- Dose mapping validation

Detergent & Detergent Disinfectant

Cleaning of floors, surfaces and equipments			
ClearKlens Plus	7515165	Manual neutral detergent, mandatory to clean the production area and remove the eventual residues of biocides. Non sterile packs available.	 Concentrated doses 10 x (10 x 30 ml)
Cleaning / disinfection of floors, walls, equipment on a daily basis			
ClearKlens Tego 2000	7516427	Amphoteric disinfectant with broad spectrum of activity. Available in concentrate and ready to use. Non sterile packs available.	6 x 900 ml spray
	7516051		4 x 5 L RTU can
	100868202 / 101103467 / 100961418 (depending on country)		Concentrated doses 50 x 50 ml
	100977672		10 x 0,9 L RTU bottle
ClearKlens Cleansinal	100848252	Detergent disinfectant, based on alkylamine and quats. Available in concentrate and ready to use. Non sterile packs available	10 x 1 L bottle
	100848253		4 x 5 L RTU can
	7516429 / 101104991 / 101103552 (depending on country)		Concentrated doses 50 x 25 ml
	7516431 / 100848254 (depending on country)		6 x 900 ml spray
Sporicides			
ClearKlens Bi-Spore	7514852	Fast acting sporicidal disinfectant. The two part system generates 50ppm of chlorine dioxide. <ul style="list-style-type: none"> • Non invasive odour • Sporicidal in 5 min (EN13704) • Virucidal in 1 min (EN 14476 : parvo, adeno, poliovirus) • Available as concentrate and ready to use Non sterile packs available.	25 x (2 doses)
	100852440		4 x 5 L can
	100852561		10 x 1 L bottle
ClearKlens Oxifast	100934589	Ready-to-use sporicidal formulation based on peracetic acid (700ppm). <ul style="list-style-type: none"> • Sporicidal in 5 min (EN13704) • Virucidal in 1 min (EN 14476: parvo, adeno, polio and norovirus) Non sterile packs available.	 8 x 1 L spray

Alcohol-based disinfectants 70%

IPA (isopropyl alcohol) - Disinfection of production tools, gloves, surfaces		
<p>ClearKlens IPA</p> 	<p>Our 900 ml trigger spray incorporates our bag-in-bottle system that allows fluid sterility of 5.5 months after the first use.</p>	<p>6 x 900 ml spray 101105062 / 101105063 / 101105064 (depending on country)</p>
		<p>Can 4 x 5 L 101104901 / 101104902 / 101104903 / 101104904 (depending on country)</p>
	<p>ClearKlens IPA 250 ml Airless Spray</p> <p>Advantages</p> <ul style="list-style-type: none"> • Reduces waste disposal costs 80% - Flat packaging after use • Ergonomics: the operator activates the spray with his wrist or his palm 	<p>12 x 0.25 L 100899521</p>
		
Disinfection of gloves without cross-contamination		
<p>ClearKlens IPA</p>	<p>Advantages</p> <ul style="list-style-type: none"> • Disinfection of gloves without contact • Photoelectric cell device / adjustable volume • Autoclavable pump (Class A / B / C / D) 	 <p>10 x 1 L bottle 101104905</p>
<p>Touchless Dispenser</p>	<p>Touchless Dispenser for ClearKlens IPA Sterile.</p>	<p>4400420</p>
70% DE (denatured ethanol) - Disinfection of production tools, gloves, surfaces		
<p>ClearKlens DE</p>	<p>Our 900 ml trigger spray incorporates our bag-in-bottle system that allows fluid sterility of 5.5 months after the first use.</p>	 <p>6 x 900 ml spray 100862174 / 101101081 (depending on country)</p> <p>4 x 5 L can 7516049</p>

Recommended Rotation Protocol

<p>Daily disinfectant (frequency based on environmental monitoring data)</p> <p>ClearKlens® Cleansinald (quats based) OR ClearKlens® Tego 2000 (Amphoteric)</p>	<p>Sporicidal agent (frequency based on environmental monitoring data)</p> <p>ClearKlens® Bi-Spore (chlorine dioxide based) OR ClearKlens® Oxifast (PAA)</p>
<p>Cleaning and Disinfection in a classified environment</p>	
<p>Routine rinsing (residue removal)</p> <p>Water For Injection OR ClearKlens® 70% IPA</p>	<p>Sterile detergents (frequency to be defined depending on the residues build up)</p> <p>ClearKlens® Plus</p>

ClearKlens® Trigger Sterile

Our sterile trigger spray “Bag in Bottle” technology maintains sterility for 5.5 months within the use area.

ClearKlens® IPA Airless

250 ml Spray

- ✓ Exclusive airless system
- ✓ No suck back through spray head



How does it work?

When the sprayer is operated, air is sucked inside the bottle through an external opening and the bag contracts when the liquid is distributed.

This allows the pressure of the air inside the bottle to be in equilibrium with that of the environment, preventing any air, which is potentially contaminated, from coming into contact with the product.

Ergonomically designed for ease of use, the bottle is designed to reduce operator fatigue:

- A long handle trigger to reduce stress.
- Designed to be held easily, even with wet gloves.



PRODUCT QUALITY

- ✓ Hermetic collapsible pouch
- ✓ Ergonomic design
- ✓ Total control of sterility - filled under Class A laminar flow into particle free bags



OPERATIONAL EFFICIENCY

- ✓ 87% reduction in waste disposal costs
- ✓ No waste left in the bottle



OPERATIONAL EFFICIENCY

- ✓ Works in all positions
- ✓ Consistent spray

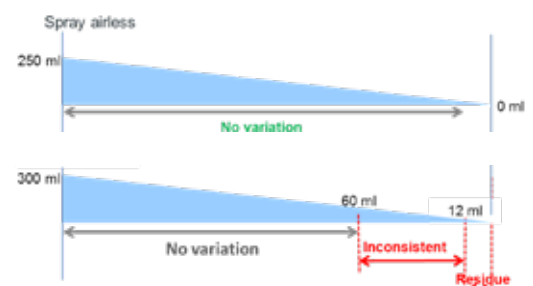

BRAND IMAGE

- ✓ Constructed from recyclable materials
- ✓ An alternative option to aluminium cans

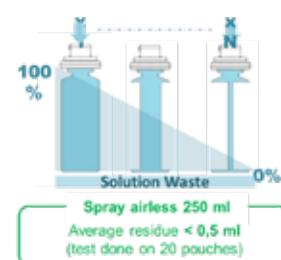
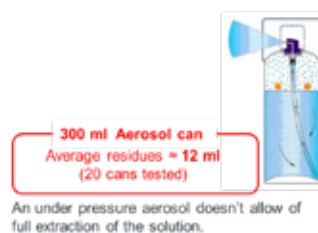

Glove disinfection - Touchless dispenser for ClearKlens IPA

A flexible dispenser solution, that combines the highest functionality, reliability and longevity. You need a dispenser that merges proven quality with the hygienic advantages of a touchless system.

Then the IMP Touchless is the dispenser system of choice

- Pump technology proven in continuous use
- Selection of materials according to hygienic viewpoints
- Touchless operation optimizes gloves hygiene
- Simple pump removal from the front
- Battery level indicator
- Designed for use with Sterile ClearKlens® IPA bottles
- Lockable cover available as an accessory

Body

- High hygienic standard through anodized aluminium surfaces
- Stress resistant construction optimized for continuous use
- Exchangeable face shield for individual product labelling

Pump and dosage

- IMP Touchless stainless steel pump, angled stainless steel suction tube, autoclavable
- Dosage amount: approx. 1.5 ml/push, reducible to approx. 0.5 ml/push

Filling

- Designed to be used with ClearKlens IPA (70% IPA, 30% WFI USP quality)

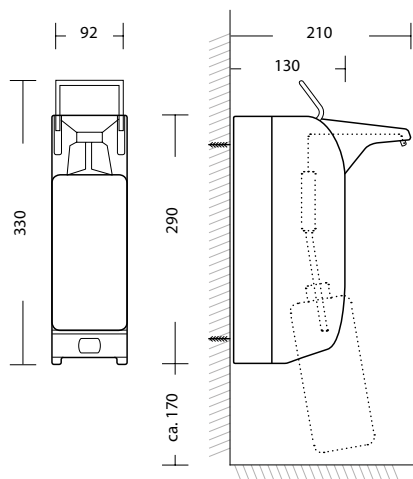

Developed to meet the specific needs of the Life Sciences Industry manufacturing facilities, the comprehensive range of ClearKlens hygiene solutions can be relied on to protect your production integrity - efficiently.



BPR supported formulations



Protected formulas



Technical documentation package



Tested to relevant EU standards

Cleaners				
ClearKlens Plus	Neutral, high-foaming liquid detergent designed for general purpose applications. Its balanced neutral formulation is particularly effective against oils and fats. (P&N free).		7513374	2 x 5 L can
			7513376	20 L can
ClearKlens Ultra	A powerful formulation, particularly effective for the removal of residues. (P free).		7517147	20 L
Taski Sprint Glass	Multi surfaces glass cleaner.		7513050	6 x 750 ml
Cleaners / disinfectants				
Tego 2000	Amphoteric disinfectant with excellent disinfectant properties against a wide range of microorganisms.		100885537	2 x 5 L can
ClearKlens Tego 2000	Amphoteric disinfectant with broad spectrum of activity. Available in concentrate, and various sterile packs.		7513381	20 L can
ClearKlens Cleansinald	A detergent disinfectant, based on alkylamine and quats. Concentrate, 1L ready to use, and various sterile packs.		7513417	2 x 5 L can conc.
			100958825	10 x 1 L RTU bottle
Oxivir Excel	Disinfectant cleaner based on hydrogen peroxide. Concentrate and ready to use packs.		100941436	2 x 5 L can (conc.)
			100941433 / 100941434 (depending on country)	6 x 750 ml spray
Oxivir Excel Wipes	Ready to use disinfection wipes, broad spectrum of efficacy, gentle on surfaces, excellent user safety profile.		101105023 / 101105022 (depending on country)	6 x 160 wipes bucket
			101105057 / 101104775 / 100984246 (depending on country)	12 x 100 wipes flowpack

IPA 70%				
ClearKlens IPA	General purpose mid-shift and terminal disinfectant based on 70% isopropyl alcohol. BPR approved.		101105065	2 x 5 L can
			101105066 / 101105067	12 x 500 ml Spray
			101105066 / 101105069	12 x 1 L bottle
ClearKlens IPA Swipe	Detergent pre-impregnated wipes based on IPA.		100868204	12 x 200 wipes
Denaturated Ethanol (DE)				
Divosan Etha Plus	Ready to use denaturated Ethanol 80% (virucidal claim).		100912913	12 x 750 ml spray
			100912911	2 x 5 L can
			100912912	20 L can
ClearKlens DE	Ready to use denaturated Ethanol 70%.		100938660	2 x 5 L can
			100983941	12 x 1 L bottle
Sporicide				
ClearKlens Oxifast	Peracetic based, ready to use disinfectant. Sporicidal efficacy at 5 min (EN13704). Sterile packs available.		100934612	8 x 1 L bottle
Oxivir Sporicide	Detergent disinfectant based on Hydrogen Peroxide. Bactericidal, Fungicidal and Virucidal. Concentrate and ready to use packs.		100941748	6 x 750 ml spray
			100941885	12 x 100 wipes
ClearKlens Bi-Spore	A fast acting sporicidal disinfectant. The two part system generates 50 ppm of chlorine dioxide. <ul style="list-style-type: none"> Sporicidal in 5 min (EN13704) Virucidal in 1 min (EN 14476) Sterile packs available.		100827588	Concentrated doses 25 x (2 x 100 ml)

ClearKlens® Oxifast



Committed to value

- ✓ Excellent sporicidal activity at 5 minutes
 - ✓ Broad spectrum of activity
 - ✓ Non-corrosive to stainless steel
 - ✓ Fully biodegradable
- Fast-acting virucidal and sporicidal disinfectant designed for hard surfaces and equipment externals in critical pharmaceutical areas
 - Ready to use solution
 - 2 years shelf life – 700 ppm PAA
 - Compatibility: suitable for use on the grades of stainless steel, PEHD, PP and all materials commonly found in the pharmaceutical industry.
 - Higher efficacy than competitor products
 - Dye and perfume free
 - Low environmental impact



Passes:

- C. albicans in 5 minutes (EN 13697)
- Polio-, Adeno-, Parvovirus in 10 minutes (EN 14476)
- B. subtilis in 5 minutes (EN 13704)

ClearKlens® Bi-Spore



Improve your disinfection procedure

Use a rapid action, sporicidal solution effective in 5 minutes

- ✓ Two part system for the creation of Chlorine Dioxide
- ✓ Designed for disinfecting hard surfaces and equipment
- ✓ ClearKlens Bi-Spore passes EN test with a shortened contact time of only 5 minutes, an important selection criterion for a Cleanroom disinfectant where wet contact times are limited.
- ✓ Also available in sterile formats

Passes:

- C. albicans in 15 min (EN 13697)
- Polio-, Adeno-, Parvovirus in 1 min (EN 14476)
- B. subtilis in 5 min (EN 13704)



Broad Spectrum Cleaner & Disinfectant for hard surfaces and non-invasive medical Devices, ideal for preventing and controlling pathogens within veterinary areas

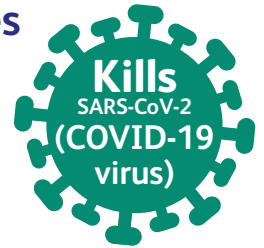

Diversey Oxivir Excel is a highly concentrated one-step cleaner disinfectant with broad spectrum efficacy and short contact times. Based on Diversey patented Accelerated Hydrogen Peroxide formulation Oxivir Excel can be used on hard, nonporous surfaces and some soft furnishings. Available as a concentrate, ready-to-use foam spray or wipes.

Key properties

- Destroys persistent enveloped and non enveloped viruses
- Bactericidal, Virucidal and Yeasticidal
- Disinfects in as little as 30 seconds
- Suitable for use in high-risk areas
- Positive user and surface safety profile
- Convenient, no preparation or laundry required
- Effective cleaner
- Fragrance free
- Active ingredient breaks down into water and oxygen
- No rinsing required
- Concentrated liquid, foam formulation or pre-wetted wipes to save time

Benefits

- Broad efficacy provides the highest levels of patient protection. Extensively tested against European norms and effective against multiple pathogens of concern
- Carries a full virucidal claim
- Suitable for outbreak control in high-risk veterinary areas, including isolation rooms/pens
- Short contact times keep the surface wet thus ensuring disinfectant efficacy
- Excellent cleaning performance, including descaling and lime limitation - removes the need for a pre-cleaning step
- Excellent user safety profile reduces worker risk, with no hazard warnings; does not contain respiratory irritants
- AHP formulation is gentle on surfaces, extending equipment life



- ✓ Available as an RTU or disposable wipe

Non-Sterile Range

Oxivir Sporicide

- ✓ Sporicidal, Mycobactericidal, Bactericidal, Virucidal, Yeastcidal and Fungicidal in as little as 1 minute
- ✓ Kills C diff in 1min in clean conditions, 3 mins in dirty conditions
- ✓ Powerful surfactant package delivers excellent cleaning performance
- ✓ Superior safety profile vs some other sporicidal agents
- ✓ Available as an RTU or disposable wipe



Mid Shift – All Surfaces

Disinfecting Wipes:
Oxivir Excel wipes



Hand Hygiene

Wash: SoftCare Wash
Disinfect: SoftCare Des E
2 in 1: SoftCare Sensisept



Floors, Walls, Ceiling, tools

Cleaner: ClearKlens Plus
Clean & disinfect:
ClearKlens Tego 2000
Sporicide: Oxivir Excel



Testing Area

Disinfection:
ClearKlens IPA or DE



Isolator – Aseptic Area

Sporicide: ClearKlens Oxifast
Disinfectant:
ClearKlens Tego 2000
Alcohol: ClearKlens IPA or DE

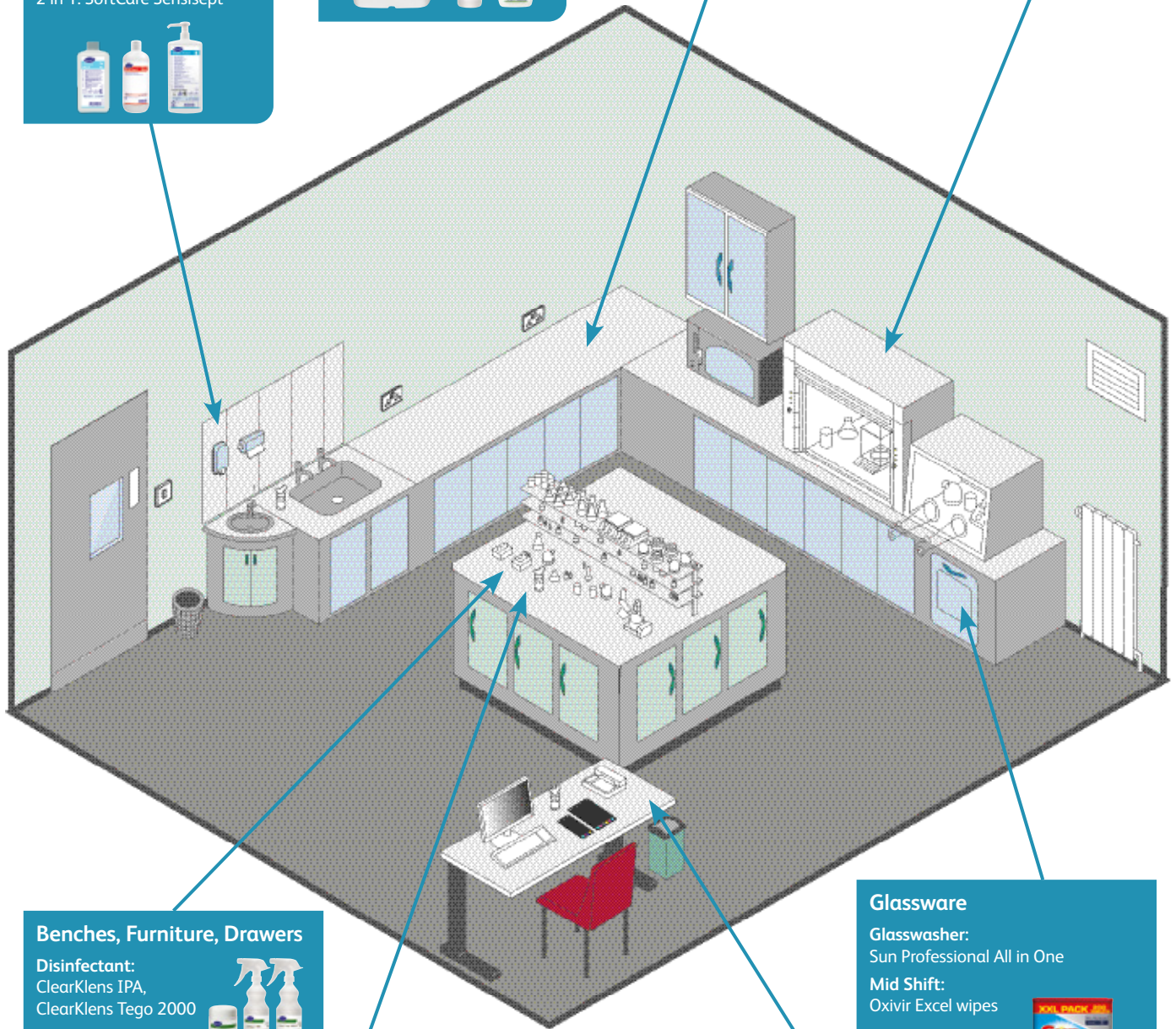

Benches, Furniture, Drawers

Disinfectant:
ClearKlens IPA,
ClearKlens Tego 2000
Cleaning Wipes:
ClearKlens IPA Swipe



Equipment / Medical Devices

Disinfection:
Oxivir Excel CE



All Purpose Virucidal Wipes

Oxivir Excel



Glassware

Glasswasher:
Sun Professional All in One
Mid Shift:
Oxivir Excel wipes



Computer, Tablet, Phone

Disinfection:
Oxivir Excel wipes



The ClearKlens product labels are designed to meet the requirements of the Life Science Industry providing the most convenient solution for the user.

1 Colour coding

The colour of the label background mirrors the pH value of the product.

Acidic products are labelled with a red colour, green means neutral, blue means alkaline and yellow means chlorinated.

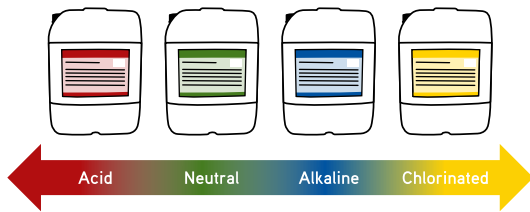

Labels of non-sterile products with small pack sizes (<5L) are designed with a grey background colour.

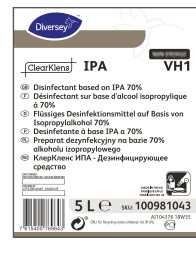
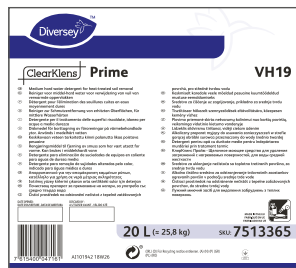
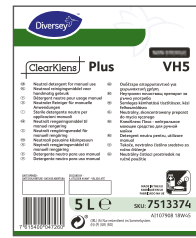

2 Sterile/Non-sterile icons

Sterile products are marked with a 'STERILE' icon on the upper right corner. Labels of non-sterile products contain a 'NON STERILE' icon.



3 'Date opened' and 'Discard by' box

Dedicated areas provide the option for users to fill in the "Date opened" and "Discard by" date.

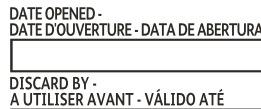

1 2

Diversey Europe Operations B.V. Maarssebroeksekdijk 2, 3542 DN Utrecht, The Netherlands. www.diversey.com

⚠ Danger: Highly flammable liquid and vapour. May cause drowsiness or dizziness. Causes serious eye irritation. Keep away from heat, hot surfaces, sparks, open flames and other ignition sources. No smoking. Store in a well-ventilated place. Keep cool. See safety data sheet for handling and safe use instructions. See product information sheet for additional information. For professional use only. (P)
 (F) Weston Favell Centre, Northampton NN3 9PD. (IE) 01 808 1808, Jamestown Road, Finglas, Dublin 11. PCs Number 95599. Active substance: Propyl 2-4-40. Directions for use: Hold the spray about 30 - 40 cm from the surface to be treated. Leave the product 5-15 min before proceeding with the cleaning.

⚠ Danger: Liquide et vapeur très inflammables. Peut provoquer somnolence ou vertiges. Provoque une sévère irritation des yeux. Tenir à l'écart de la chaleur, des surfaces chaudes, des étincelles, des flammes nues et de tout autre foyer de chaleur. Ne pas fumer. Stocker dans un endroit bien ventilé. Tenir au frais. Consulter la fiche de données de sécurité pour le manipulation et de plus d'informations. Voir la fiche technique. Uniquement pour usage professionnel. (P)
 (F) 01 45 14 76 76, 201, rue Comtes - 94120 Fontenay sous Bois. Substances actives: propyle 2-4-40 (CAS N° 67-65-18, 84 %), (v/v). Mode d'emploi: (P) Liquide: Imposer localement, bécoté 192 J unites sur toutes surfaces (toits, parois, mobilier) et pour le matériel de nettoyage. Laisser agir 5 à 15 min selon l'inflammabilité. Bécoté: selon EN1040, EN1278 et EN13697. Fongicide selon les normes EN1275, EN1650, EN13697. Se référer au protocole en place en ce qui concerne la fréquence d'application à respecter. Éliminer le produit et son résidu comme un déchet dangereux. Date d'expiration: se référer à la date imprimée sur le contenant. Transport: se référer aux prescriptions relatives au transport des marchandises dangereuses. (C) 071 969 2727. Echikontorrasa, 9542 Michailovtsi. Numero de registrasiõ: CH2N339.

⚠ Gefahr: Flüssigkeit und Dampf leicht entzündbar. Kann Schläfrigkeit und Benommenheit verursachen. Verursacht schwere Augenirritation. Nicht rauchen. Kühl an einem gut belüfteten Ort aufbewahren. Beachten Sie die Sicherheitsdatenblätter und Anweisungen für sichere Anwendung. Weitere Informationen entnehmen Sie bitte dem Produktdatenblatt. (P)
 (F) Pour la désinfection des surfaces parfaites. Dosage: Produit prêt à l'emploi - vaporiser sans dilution. Vaporiser sur une surface propre. Vaporiser le spray à 30 à 40 cm de la surface à traiter. Vaporiser directement sur la surface propre pour une humidification complète. Bécoté: bécoté standard. Laisser agir pour 30 sec. Mycofongicide: Laisser agir pour 60 sec. Fongicide (levures): Candida Laisser agir pour 30 sec. Inflammation: laisser agir pour 30 sec. Les surfaces doivent rester humides pendant toute la durée d'action. A cause d'un risque d'explosion, seuls des petits bécotés peuvent être traités. Il n'est pas nécessaire de les rincer. Fermer la bouteille après usage. Pour plus d'informations, se référer à la Fiche Technique du produit. Uniquement pour usage professionnel.

⚠ Gefahr: Flüssigkeit und Dampf leicht entzündbar. Kann Schläfrigkeit und Benommenheit verursachen. Verursacht schwere Augenirritation. Nicht rauchen. Kühl an einem gut belüfteten Ort aufbewahren. Beachten Sie die Sicherheitsdatenblätter und Anweisungen für sichere Anwendung. Weitere Informationen entnehmen Sie bitte dem Produktdatenblatt. (P)
 (F) Pour la désinfection des surfaces parfaites. Dosage: Produit prêt à l'emploi - vaporiser sans dilution. Vaporiser sur une surface propre. Vaporiser le spray à 30 à 40 cm de la surface à traiter. Vaporiser directement sur la surface propre pour une humidification complète. Bécoté: bécoté standard. Laisser agir pour 30 sec. Mycofongicide: Laisser agir pour 60 sec. Fongicide (levures): Candida Laisser agir pour 30 sec. Inflammation: laisser agir pour 30 sec. Les surfaces doivent rester humides pendant toute la durée d'action. A cause d'un risque d'explosion, seuls des petits bécotés peuvent être traités. Il n'est pas nécessaire de les rincer. Fermer la bouteille après usage. Pour plus d'informations, se référer à la Fiche Technique du produit. Uniquement pour usage professionnel.

Contains/Contient/Enthält/Contiene/Contém/Zawiera/Coccos: Isopropyl Alcohol.

⚠ Gefahr: Flüssigkeit und Dampf leicht entzündbar. Kann Schläfrigkeit und Benommenheit verursachen. Verursacht schwere Augenirritation. Nicht rauchen. Kühl an einem gut belüfteten Ort aufbewahren. Beachten Sie die Sicherheitsdatenblätter und Anweisungen für sichere Anwendung. Weitere Informationen entnehmen Sie bitte dem Produktdatenblatt. (P)
 (F) Pour la désinfection des surfaces parfaites. Dosage: Produit prêt à l'emploi - vaporiser sans dilution. Vaporiser sur une surface propre. Vaporiser le spray à 30 à 40 cm de la surface à traiter. Vaporiser directement sur la surface propre pour une humidification complète. Bécoté: bécoté standard. Laisser agir pour 30 sec. Mycofongicide: Laisser agir pour 60 sec. Fongicide (levures): Candida Laisser agir pour 30 sec. Inflammation: laisser agir pour 30 sec. Les surfaces doivent rester humides pendant toute la durée d'action. A cause d'un risque d'explosion, seuls des petits bécotés peuvent être traités. Il n'est pas nécessaire de les rincer. Fermer la bouteille après usage. Pour plus d'informations, se référer à la Fiche Technique du produit. Uniquement pour usage professionnel.

⚠ Gefahr: Flüssigkeit und Dampf leicht entzündbar. Kann Schläfrigkeit und Benommenheit verursachen. Verursacht schwere Augenirritation. Nicht rauchen. Kühl an einem gut belüfteten Ort aufbewahren. Beachten Sie die Sicherheitsdatenblätter und Anweisungen für sichere Anwendung. Weitere Informationen entnehmen Sie bitte dem Produktdatenblatt. (P)
 (F) Pour la désinfection des surfaces parfaites. Dosage: Produit prêt à l'emploi - vaporiser sans dilution. Vaporiser sur une surface propre. Vaporiser le spray à 30 à 40 cm de la surface à traiter. Vaporiser directement sur la surface propre pour une humidification complète. Bécoté: bécoté standard. Laisser agir pour 30 sec. Mycofongicide: Laisser agir pour 60 sec. Fongicide (levures): Candida Laisser agir pour 30 sec. Inflammation: laisser agir pour 30 sec. Les surfaces doivent rester humides pendant toute la durée d'action. A cause d'un risque d'explosion, seuls des petits bécotés peuvent être traités. Il n'est pas nécessaire de les rincer. Fermer la bouteille après usage. Pour plus d'informations, se référer à la Fiche Technique du produit. Uniquement pour usage professionnel.

⚠ Gefahr: Flüssigkeit und Dampf leicht entzündbar. Kann Schläfrigkeit und Benommenheit verursachen. Verursacht schwere Augenirritation. Nicht rauchen. Kühl an einem gut belüfteten Ort aufbewahren. Beachten Sie die Sicherheitsdatenblätter und Anweisungen für sichere Anwendung. Weitere Informationen entnehmen Sie bitte dem Produktdatenblatt. (P)
 (F) Pour la désinfection des surfaces parfaites. Dosage: Produit prêt à l'emploi - vaporiser sans dilution. Vaporiser sur une surface propre. Vaporiser le spray à 30 à 40 cm de la surface à traiter. Vaporiser directement sur la surface propre pour une humidification complète. Bécoté: bécoté standard. Laisser agir pour 30 sec. Mycofongicide: Laisser agir pour 60 sec. Fongicide (levures): Candida Laisser agir pour 30 sec. Inflammation: laisser agir pour 30 sec. Les surfaces doivent rester humides pendant toute la durée d'action. A cause d'un risque d'explosion, seuls des petits bécotés peuvent être traités. Il n'est pas nécessaire de les rincer. Fermer la bouteille après usage. Pour plus d'informations, se référer à la Fiche Technique du produit. Uniquement pour usage professionnel.

DATE OPENED: DATE D'OUVERTURE - DATA DE ABERTURA
 DISCARD BY: A UTILISER AVANT - VÁLIDO ATÉ

MADE IN THE EU
 FABRIQUÉ EN UE
 FABRICADO NA UE

0,9 L e
 SKU: 7513400
 A1110885 19W04

(R) Für Recycling restos
 enterreos. (A) (P) (PL)

7 615400 047567

Voyager

If you are looking for an all-in-one flexible mobile cleaning solution, look no further. The Voyager range enables foam application disinfection and rinsing of large areas from one unit. The Voyager's built-in pump boosts the water pressure of your existing water supply, just connect the unit up to a water, power and compressed air* supplies to start benefiting from efficient cleaning. There are a number of optional extras for the Voyager range, including an extra rinsing outlet or a separate foam or disinfectant injector with separate outlet, thus allowing two persons to work simultaneously from the same unit.

*Voyager K models incorporate their own compressor for sites without a compressed air supply.



Modular Wash Down Systems

Our range of modular wash down equipment is designed to deliver optimum distribution, dilution and application of foam detergents, disinfectants and rinsing around your facility. Easy to install and maintain, constructed from high quality material to hygienic designs.

Choose from a single stand alone main station, delivering optimum foam for cleaning and disinfection, or add additional satellites to the main station, or incorporate a central pump station to pressurize your water supply to feed a number of satellites.

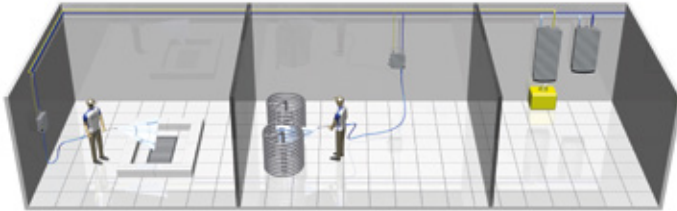

CENTRAL MANUAL CLEANING - Central pump station pressurising multiple satellites

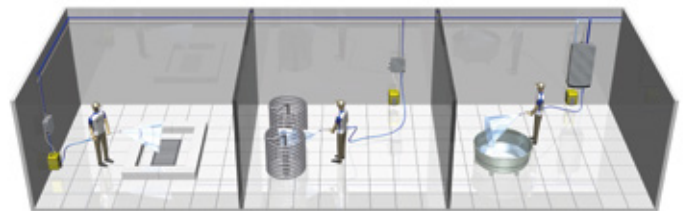

DECENTRAL MANUAL CLEANING - Central or local chemical supply

Example of Cleaning Protocol

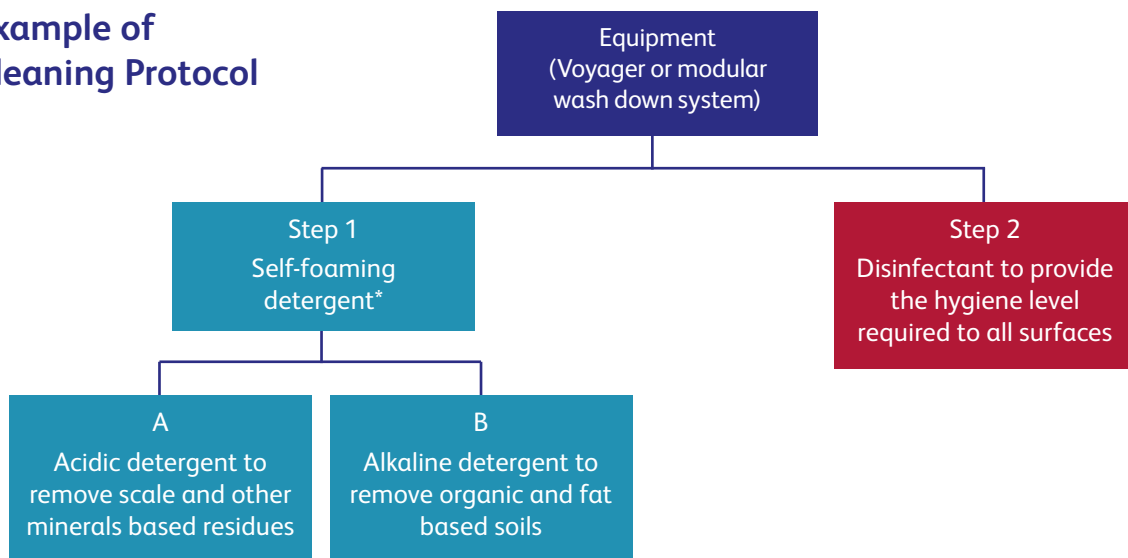

* Nitrogen and Phosphate free detergent available

Why use medium pressure?

Efficiency during pre-wash and final rinse.

Cleaning principles:

After pre-rinse with mid pressure, the cleaning is achieved by applying a foaming detergent on all the surfaces to be cleaned including vertical ones and mechanical parts.

The foam created under these conditions is able to cover surfaces between the mechanical parts with detergent which are critical regarding hygiene.

Benefits during rinsing steps:

During the pre-rinse step, usage of mid-pressurized water (between 8 and 40 bars) enables to be under the most efficient conditions versus the other standard domains of water pressure (low pressure under 5 bars / high pressure over 50 bars).

Usage of mid-pressurized water with rotative and fixed nozzles provides the optimal mechanical impact on soils.

It is obvious that a pre-rinse with mid-pressurized water will provide better results than a pre-rinse done with water at low pressure thanks to an improved mechanical impact on the soils.

For the same results, it is quite common to reduce by half the cleaning time which is a major benefit if you consider the total cost of cleaning.

For the same mechanical effect, the usage of mid-pressurized water avoids also some of the secondary effects due to the usage of high pressure:

Soils are not randomly exploded but conveyed towards the drains.

Calorie losses are reduced. The usage of hot water is optimized : the temperature of the water after the nozzle remains high enough to dissolve fat soils.

The mechanical effect obtained with mid-pressure is still effective 30 cm after the nozzle which brings efficacy even on biofilms. The mechanical effect obtained with high pressure drops down significantly 10 cm after the nozzle.

Aerosol creation is reduced with mid-pressure which limits cross-contamination by air.

As humidity and the vibrations of the machines remain limited during pre-rinse step, we generally observe a reduction of the cost of maintenance for production equipments when you pass from high to mid-pressure for rinsing steps.

Benefits during cleaning steps

A complete unit producing mid-pressurized water and foam by automatic dilution of cleaning products enables to:

- Save the time to prepare the foam pots
- Reduce significantly the handling of chemicals by operators
- Keep under control cleaning product concentration which directly influences cost and results of the cleaning method.



Satellite S1 SEE



Satellite S2 SEE



Satellite S4 SEE

Cleaning In Place (CIP)

Diversey provides unrivalled CIP knowledge. Our strength and competence comes from decades of field experience, application knowledge, understanding of chemistry, system engineering, game changing innovations and a world class portfolio of products. Starting with a full analysis of your specific CIP needs, leading to retrofitting, upgrading or fine-tuning of existing installations or the design and implementation of a fully integrated CIP system, we apply our knowledge and expertise to deliver a solution that will revolutionize speed, hygiene standards and efficiency at your plant.

Our dedicated team of CIP process engineers will simplify your CIP operations, however complex they may be. We work closely with your team in auditing existing CIP installations to obtain a detailed understanding of your needs. Our innovative CIP product formulations coupled with the expertise and process knowledge deliver:

- Lower energy consumption
- Lower water usage
- Process consistency with repeatable results
- Shortened cleaning time

Widest range of CIP detergents for all kinds of soils and surfaces. Proven CIP programs for all products:

- Lower energy consumption
- Lower water usage
- Process consistency with repeatable results
- Shortened cleaning time

All products and programs with complete residue estimation, regulatory and validation support.

The non-sterile range, developed for cleaning and disinfection of Pharmaceutical and Cosmetic manufacturing facilities.

Clean in place systems (CIP)

- Cleaning of tanks, vats and vessels
- Speciality products for CIP cleaning and disinfection
- Single step solutions
- Mini CIP: allowing water, time and product optimization



Cleaning In Place (CIP)

The extensive Diversey CIP chemical range offers non foaming detergents and disinfectants designed for circulation through process equipment. The combined effects of solutions turbulence, chemical energy and heat remove soil debris and microorganism from pile work and ancillary plant without time consuming dismantling and manual cleaning.



BPR supported formulations



Protected formulas



Technical documentation package



Tested to relevant EU standards

Alkaline Detergents for CIP

To clean pastes, ointments, emulsions, and formulations based on titanium oxide. To clean dry forms including tablets, sachets, powders, eudragit. To clean mixing tanks and fermenters, vaccines

ClearKlens Flowcert	The alkaline detergent to remove soil from natural and organic cosmetic production – Ecocert certified		100865820	20 L
ClearKlens Multi	Highly concentrated detergent-solvents, based on organic solvents and surfactants used for a wide range of applications <ul style="list-style-type: none"> • Excellent dirt-carrying capacity • Good rinsing properties 		100845236	20 L
ClearKlens NTC	Alkaline mid-strength detergent – soda, sequestrant and tensio-actives <ul style="list-style-type: none"> • Effective for a single phase cleaning • Non-foaming • Suitable for CIP systems under conditions of high turbulences 		7513363	20 L
			7513364	950 L
ClearKlens NTC L	<ul style="list-style-type: none"> • EDTA-free, multi purpose, alkaline detergent/blend of sequestrants and surfactants 		7518462	20 L
			7522874	950 L
ClearKlens Spek	Caustic detergent, medium hard water tolerant <ul style="list-style-type: none"> • Hard water tolerant • Highly effective at removing a wide range of organic soils • Preventing scale build up 		7513359	20 L
			7521897	900 L
ClearKlens Prime	Caustic detergent, medium hard water tolerant <ul style="list-style-type: none"> • Used for the removal of heavy duty soiling in the fermentation broth process • Suitable for use in tray, crate and mould cleaning applications 		7513365	20 L
			7513366	200 L
Polypro	Soft metal safe alkaline silicated CIP detergent <ul style="list-style-type: none"> • Provides excellent detergency against a wide range of fats and oils • Ideal for use on aluminium and other soft metal equipment • Hard water tolerant 		7516323	20 L
ClearKlens Flow	Strong Alkaline Detergent <ul style="list-style-type: none"> • For use in hard water • Specially formulated to prevent deposits of tartar during the final rinse • Effective for the removal of most organic stains 		7513367	20 L
			7513368	950 L

Cleaning In Place (CIP)

Acidic Detergents To clean equipment and glassware			
ClearKlens ECO	Defoamed, organic acid detergent decaler for general CIP <ul style="list-style-type: none"> Citric acid, sulfamic, glycolic, very low Phosphors and nitrogen content Its defoaming properties make it suitable for use under conditions of high pressure and turbulence, improving cleaning performance 	7519182	20 L
ClearKlens Release	Acidic detergent descaler <ul style="list-style-type: none"> Very efficient for tablet coating removal Low foaming Low level of phosphorus 	7520002	20 L
ClearKlens Scale	Descaling detergent with phosphoric acid base <ul style="list-style-type: none"> Highly effective to remove stains and minerals 	7513355	20 L
ClearKlens Dilac	Heavy duty acidic CIP detergent descaler <ul style="list-style-type: none"> Highly effective at removing inorganic scale deposits Can be used for the passivation of new stainless steel CIP installations 	7518612	20 L
ClearKlens Brite	Defoamed phosphoric acid based CIP detergent <ul style="list-style-type: none"> Can be used at ambient up to 50°C Suitable for use under conditions of high pressure and turbulence Enhanced wetting and dispersing properties 	7517222	20 L
		7513356	200 L
		7513357	900 L
ClearKlens IM	Acidic CIP cleaner and descaler <ul style="list-style-type: none"> Low foaming Suitable for CIP, spray, wash and soaking applications Free of surfactants and easily rinsable Non corrosive, non oxidising 	7517640	20 L
		7517641	200 L
		7517897	950 L
Chlorinated detergent/disinfectant			
ClearKlens Deogen	Chlorinated detergent-disinfectant for soft/medium hard water <ul style="list-style-type: none"> Low foaming under conditions of high turbulence High active chlorine level effectively removes soils, stains and off-flavours Broad spectrum disinfectant action Free-rinsing, minimizes water usage 	7522374	20 L
Disinfectants/ Disinfectant detergents After pre-cleaning pastes, ointments and emulsions. For cleaning and disinfect mixing tanks, fermenters			
Clearklens MEGA HP / Divosan Omega MEGA HP	One-Phase disinfectant Detergent <ul style="list-style-type: none"> Alkaline based formulation of sequestering and surfactant agents Chlorine free, effective disinfectant action Suitable for use in soft or hard water 	7519460	20 L
		7518465	950 L
ClearKlens Activ	Disinfectant 5% <ul style="list-style-type: none"> Stabilised peracetic acid solution Non-foaming Highly effective against all types of micro-organisms including bacteria, fungi, spores and viruses Can be used as rotational sporicidal disinfectant for environmental disinfection 	7513388	20 L
		101100582	950 L CDS
Additives			
ClearKlens Kristalle	Low foaming additive, promotes dispersion and the elimination of stains <ul style="list-style-type: none"> without nitrogen and phosphorus-free 	7513380	20 L
Booster	Booster is an additive to alkaline detergents for the removal of organic deposits	7517892	20 L
ClearKlens Copper Plus	Low foaming, alkaline additive to caustic for use in CIP <ul style="list-style-type: none"> Specially effective against high level of product residue (pills, drugs, mineral oils, wax, etc.) Can be also used on its own 	7519183	20 L

Cleaning In Place (CIP)

Passivation of Stainless Steel

Protecting and Prolonging your Stainless Steel Installations

During the manufacturing process, stainless steel equipment will expand and contract with heating and cooling. It will also come into contact with various product recipes; production processes such as fermentation, pasteurization or sterilization; cleaning chemicals; and physical abrasion from actions like brushing, grinding, scraping, mixing. All of which can damage and weaken the protective surface layer leaving the iron underneath exposed and susceptible to corrosion.

Food and beverage processors and companies within the life sciences sector routinely undertake chemical passivation on stainless steel installations to protect the equipment from corrosion which could lead to product contamination and cause a brand-damaging safety issue.

Diversey's range of passivation chemistry has been developed to provide an effective solution depending on the impact of surrounding influences such as product type or water hardness while considering the impact on the environment. Our representatives will be able to advise the best option depending on your specific requirements.



Cleaning In Place (CIP)

Cannabis & Hemp Extraction Solutions

Leaders in an emerging Industry

Diversey and our global distribution partners are uniquely positioned to provide unequaled value to the Life Science industry. Whether you are engaging in further processing, extraction, and / or cultivation, Diversey and its partners are there to ensure your operation's processes are fully optimized in accordance with Good Processing Practices (GPPs) and Good Manufacturing practices (GMPs).

Harnessing over 95 years of expertise and knowledge, Diversey develops innovative cleaning technologies, providing a tailored, customer-centric approach that empowers sustainable solutions. Protecting and improving the environment, we operate with our customers' needs at the heart of everything we do. Our mission is to protect and care for people every day by pioneering future focused cleaning and hygiene technologies.

Industry Value Chain

Whether your value chain includes cultivation, further processing and/or extraction, Diversey will work with you to ensure your product meets the quality that your end client demands. We will partner with you to drive costs out of your operations to ensure your company is sustainable throughout time.

- Automated tray washers
- Extractor CIP skids
- COP tanks for part washing
- Portable and centralized cleaning systems

Knowledge that Provides Synergies

Our strength and competence comes from application expertise, system engineering and field experience. The synergies derived from this combination are provided by Advanced Engineering Solutions for customers. Diversey experts will undertake a full study of your specific requirements.

We will design engineering solutions based on a deep understanding of your needs and a full analysis of the processes that affect the core areas of your business. Diversey's solutions are based on innovative, state-of-the-art processes that use the best and proven practices to create customized solutions, excellent hygiene standards and more efficient cleaning processes.

- Open Plant Cleaning (OPC)
- External Filler Cleaning (EFC)
- Cleaning in Place (CIP)
- Clean Out of Place (COP)
- Track Treatment
- Bulk Storage, Chemical Consumption
- Management & Chemical Room Design
- On-Site Biocide Generation
- Caustic Recovery

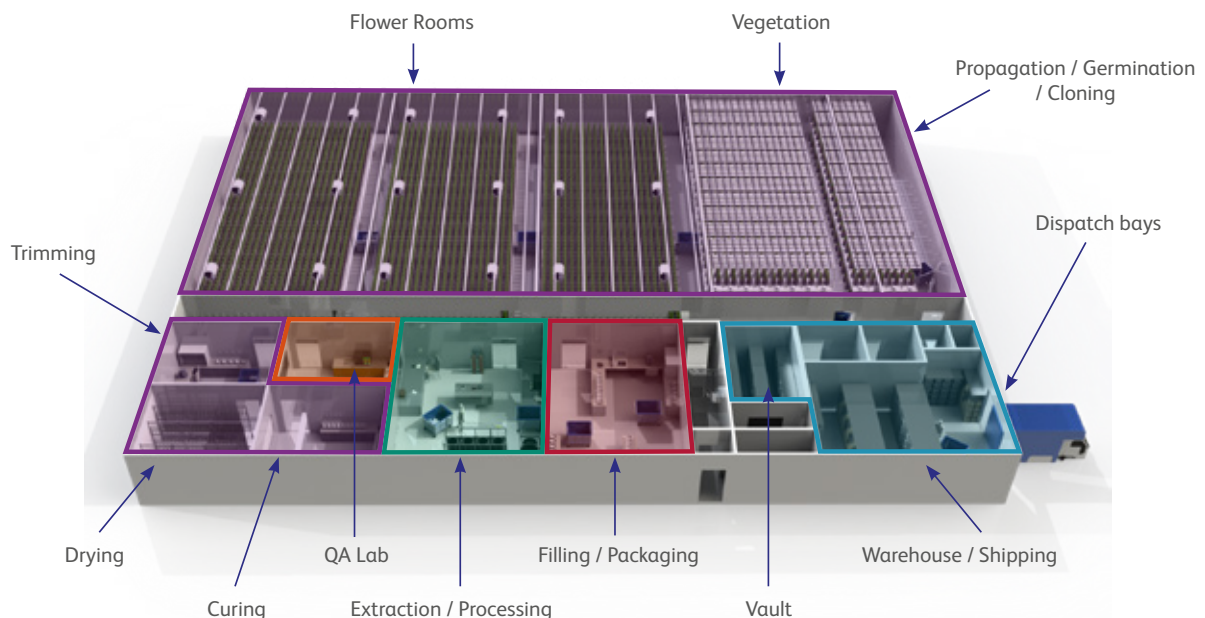
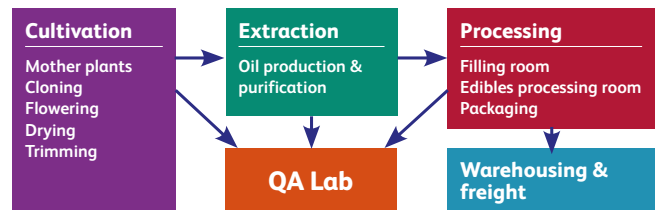

SURE-the Power of Nature

Plant-based, 100% biodegradable cleaning products designed to deliver superior professional results.

With environmentally-friendly ingredients from renewable resources, SURE products meet all your daily requirements for facilities and personal care.



SURE Cleaning & Disinfection for Surfaces

SURE Cleaner Disinfectant Spray	Ready-to-use detergent disinfectant for the cleaning and disinfection of all surfaces.
SURE Cleaner Disinfectant (Conc)	Concentrated detergent disinfectant for the cleaning and disinfection of all surfaces.
SURE Cleaner & Degreaser	Concentrated heavy-duty degreaser for cleaning all heavily soiled surfaces. Also suitable for heavy-duty cleaning of floors and for top stripping.

Sure Cleaning & Disinfection for Personal Care

SURE Hand Wash Free	Gentle and effective hand wash without perfumes or dyes.
SURE Antibac Hand Wash	Antibacterial hand wash for Soft Care dispenser that ensures the highest disinfectant standards.





Professional hand washing is easy thanks to a range that covers all the needs in personal hygiene.

- Innovative solutions that work in all areas of application
- The liquid and foam option and pleasant scents
- The best formulations for tested and proven efficacy
- Dermatologically tested formulations
- Products with a universal colour code

Softcare

Washing/care			
SURE Hand Wash	A mild scented soap for hands containing herbal actives - no parabens or preservatives	100938652	4 x 1.3 L
Soft Care All Purpose	Ideal for hands, body, hair. Delicate fragrance	100938558	4 x 1.3 L
Soft Care All Purpose Foam	Ideal for hands, body, hair. Delicate fragrance	100940173	4 x 1.3 L
Soft Care Derasoft	Hand rehydration cream	100938654	4 x 1.3 L
Disinfection			
Soft Care Des E	Ethanol-based hydroalcoholic solution - without perfume or colouring	100939047	4 x 1.3 L
		100860436	50 x 100 ml
		100860440	2 x 5 L
Soft Care Med	Alcoholic hydro Solution containing moisturizing agents-without fragrance or dye	100938824	4 x 1.3 L
2 in 1 – Washing and disinfection			
Soft Care Sensisept	Disinfectant Soap -No fragrance or dye	100938899	4 x 1.3 L

The IntelliCare™ dispenser is compatible with liquid, foam or cream products. Possibility of choosing the dose of product to dispense (high or low)

An intelligent 1.3 L package that allows you to:

- See the remaining level with a patented bottle design that collapses from the back
- Reduce waste with a collapsible bottle that empties fully
- Easily replenish the bottle with an intuitive click mechanisms

Intellicare

Hybrid dispenser		
Hybrid Soft Care All Purpose	Black D7524179	4 x 1.3 L
	White D7524180	4 x 1.3 L
Manual	Black D7524177	4 x 1.3 L
	White D7524178	4 x 1.3 L



Facility Hygiene - TASKI

TASKI[®]

The easiest way to a perfect facility care

Diversey chemicals are superior on their own and when combined with our machines give you the best possible solution.

Machines & Equipment

TASKI machines clean effectively while reducing water, chemical and energy consumption. Incredibly durable, they've undergone some of the industry's most rigorous testing in the harshest of conditions.



Chemical cleaning products

Diversey provides a complete range of hygiene solutions for your facility hygiene protocol.



Floor



Surface



Glass



Intellibot



Mobile work stations



Mops and Microfiber Cloths

Knowledge-Based Systems (KBS)

A holistic approach to constantly measure, monitor and improve operational efficiency and product safety throughout your operations.

The Diversey Knowledge-Based Services portfolio addresses key Life Sciences industry challenges: Productivity, Water, Energy, and Product Safety. The services share a common three-step 'Check, Analysis and Solve' approach to continually improve safety and operational efficiency in Life Sciences productions.

ClearKlens® DSP - Detergent Selection Program



The detergent selection program delivers you an efficient protocol and chemical selection to clean your specific soil, accelerating your cleaning standard operating procedure (SOP) development.

ClearKlens® DSP ensures that the best cleaning chemical and procedure are selected for each soil. Benefit from having a team of experts working in close contact with your needs to select the most efficient solution given the utilities available at your site and taking into account the entire ClearKlens® portfolio.

As easy as sending a sample.

A sample of the soil is sent to the DSP technical team to be assessed. The technical centre will test different cleaning chemistry and procedures and then provide a report that details the best method. This report can then be used to develop your cleaning protocol based on the parameters defined including, chemical type, concentration, cleaning time, temperature, cleaning method and water quality.



DSP Example

Plate weight	Soiled plate weight (g) before test	Contamination (mg/cm ²)	Plate weight after test (g)	Contamination removed (mg/cm ²)	Cleaning performance (%)
57.93	58.64	30.11	57.93	30.11	100

Summary best cleaning results after 15'

Application	Detergent (5% v/v)	Additive (1% v/v)	pH
CIP	ClearKlens NTC VH18L	Booster	Alkaline
CIP	ClearKlens NTC VH18L	ClearKlens Multi	Alkaline
CIP	ClearKlens Multi	-	Alkaline
CIP	ClearKlens Dilac	-	Acid
CIP	ClearKlens Kristalle	-	Neutral

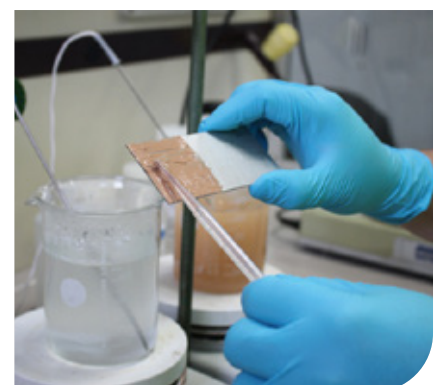

Challenge

Water plays a critical role in your manufacturing process. As one of our most important natural resources, water, and monitoring of its use, has become an integral part of responsible business practices.

Whether the goal is reaching your corporate sustainability metric or with an eye toward cost management, prudent water use has become a business necessity.

Holistic management of your water consumption has the potential to reduce water and wastewater volumes by up to and in some cases over 30%. With water accounting for 30% of the average manufacturers utility costs* the impact on your financials can be as significant as the impact on your sustainability goals.

Solution

Using Diversey AquaCheck, you can optimise water consumption and control costs, create a safer environment for employees, and identify water losses that, when addressed, will lead to utility savings with low capital investment.

*Based on results achieved by Diversey. All facilities are different. The impact for your site will be calculated as part of an initial Diversey AquaCheck scan.



On average water accounts for **30%** of your overall utility bill*

Benefits

With Diversey AquaCheck you can:

- Improve your water utilisation
- Measure and trace all sources of water waste
- Reduce your water and effluent treatment, further improving your economic and environmental performance
- Determine whether incremental improvements will improve efficiency
- Prioritize areas of improvement and take action
- Benchmark your business against industry performance using AquaCheck's analytic tools.

Best-in-class cleaning in place optimisation:

Using Diversey CIPCheck, you will benefit from a detailed analysis of your use of energy, chemicals and time spent to identify areas of improvement. Using this information, our teams will develop and implement an action plan to generate immediate productivity gains and energy savings while maintaining – and in many cases, improving your hygiene standards.

75%
of CIP cleanings run un-optimized, using original settings



Easy and immediate access to your CIP performance

Quick and Easy Access to Cleaning in Place Performance

The effectiveness of each CIP run is buried within the automation system or manually tracked through documentation. Knowing if cycles are over-using resources, or have the potential to cause a contamination risk because hygiene parameters were not met, is largely unexplored.

What if you could quickly and easily see where your CIP may be causing losses and risks to your brand? What if you could analyze and compare cleaning runs to truly understand which of your processes are in control?

What is Diversey Intelligent CIP?

Diversey Intelligent CIP is a cloud-based, remote monitoring and data analysis tool for CIP (cleaning in place) data.

Diversey Intelligent CIP translates measured CIP data into visual, easy to understand, actionable information. The curtain is removed and the details of each CIP run are discovered, providing proof of compliance and indicators of where to optimize. It brings clarity to CIP data and enables to uncover the true operation of the CIP System.

Process, analyze, monitor and compare all your CIP data points to truly understand if your process is in control

Hygiene

- Evaluates each CIP Cleaning process
- Computes effective cleaning times within the recipe's cleaning protocols and visualizing them
- Helps compare the same program on multiple objects
- Facilitates object-based CIP program customization
- Repeatability control

Efficiency

- Finds overshooting on the actual CIP program
- Evaluate step times- Rinse water usage and rinse time
- Pinpoint chemical use and losses
- Improve energy loss and maintenance by addressing overheating (flagged temperatures)

Intelligent CIP receives data from your CIP

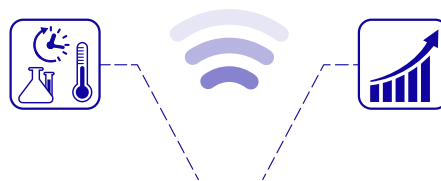

Intelligent CIP converts data into actionable information

Continuous process monitoring

- Uncover and troubleshoot outliers and process deviations
- Program and cleaning statistics
- Repeatability analysis per object / object group / per program / program step
- Permanent process validation

KPI Management

- Track and report utility use (time, energy, water and chemistry) to help manage and control costs
- Document cleaning compliance enabling traceability and audit requirements
- Record product safety, efficiency and quality improvements using a statistical process

Compliance at a Glance

- At your desk – have a quick view of your CIP process for any date range, specific unit, CIP circuit, or recipe
- Drill down to a specific cleaning run and view or download a compliance report that compares the site's quality standard protocols vs actual data. The report highlights hygiene concerns or efficiency opportunities

Continuous Improvement

- Know if your process is in control
- Learn which CIP recipes can be effectively optimized to operate more sustainably
- Compare each cleaning run of a specific recipe using a six sigma distribution curve

Hygiene Academy

The Diversey Hygiene Academy allows you to manage and deploy your own trainings and integrate our reference knowledge into your processes.

Better than just following the needs of the industry:
Accredited training courses!

Diversey e-Learning Management Systems

- Accessing the latest Cloud training platform simplifying the administration of training for your employees
- Remove costs from your training budget
- Providing a solid training opportunity for your production forces

A Cloud solution that fits your business

Create, print and sign training certificates and add time to completion

Latest cloud technology that improves user experience and minimises set up time

Increase accountability by tracking employee participation and provide documentation to workers and supervisors

No software or expensive hardware required

Save time and reduce the cost of traditional training

Personalize with your own logos and brands

Powerful reporting capabilities to monitor employee participation, performance and progress





Taking care of
what's precious™

Diversey's purpose is to go beyond clean to take care of what's precious through leading hygiene, infection prevention, and cleaning solutions. We develop and deliver innovative products, services, and technologies that save lives and protect our environment. For over a century, the Diversey brand has become synonymous with product quality, service, and innovation.

Our fully-integrated suite of solutions combines patented chemicals, dosing and dispensing equipment, cleaning machines, services, and digital analysis. We are a trusted partner; serving more than 85,000 customers in over 100 countries with a network of almost 9000 employees globally.

For more information, visit www.diversey.com or follow us on social media.



pharma@diversey.com
www.diversey.com